



SYLRO

Sunvent Industries, a division of Sylro Sales Corporation, has been manufacturing both extruded and cast aluminum BRICK and BLOCK VENTS and accessories for over 45 years. As the largest exclusive manufacturer in the nation, Sunvent Industries offers a full line of extruded and cast aluminum vents.

Available for immediate shipment, we carry a full line of extruded vents in various finishes including mill, 204-R1 clear anodized as well as medium and dark bronze anodized. Our extruded vents can readily be manufactured in custom sizes. Additionally in stock, we carry a full line of cast aluminum vents in mill finish.

Upon request, our extruded and cast aluminum vents are offered in baked enamel and kynar finishes.

Sunvent Industries is committed to providing quality workmanship in the products shipped to you and your customers. We take great pride in the vents we manufacture and ensure you will be satisfied with our high degree of service and efficiency.

Our vents are of the best quality and are all a minimum of .125" thick, perfect for the commercial/industrial market as well as for use in high vandal areas.

Aluminum Brick Vents



EX SERIES EXTRUDED ALUMINUM VENTS



FL SERIES EXTRUDED ALUMINUM FLANGE VENTS



C SERIES CAST ALUMINUM VENTS



sunvent

Cast Aluminum Vents

SYLRO

EXCLUSIVE FEATURES

- **Minimum .125" thick**
- **Mill finish**
- **Continuous weepage on bottom**
- **1" Deep Overlapping Blades**
- **Water stop at rear**
- **One piece molded unit**
- **Load bearing**

Sunvent "C" Cast Aluminum Vents are made of high corrosion resistant alloy #319. All castings come with aluminum insect screen 7 x 7 mesh. The vents are designed with a deep louvered face and a continuous water stop set far back on the inside of the casting, a combination that prevents water from entering the building. There is a drip at the top and bottom of the casting to prevent water staining or spawling of the brick.

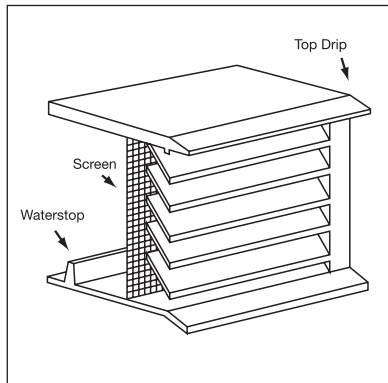

C SERIES CAST ALUMINUM VENTS

CAST ALUMINUM STOCK VENT SIZES

4" Deep	Order Sizes (See note 3) W X H
C 825	8" x 2-1/4"
C 847	8-1/4" x 4-15/16"
C 808	8" x 7-7/8"
C 123	12" x 2-3/4"
C 124	12" x 3-1/2"
C 125	12" x 5"
C 128	12" x 7-3/4"
C 162	16-1/2" x 2-3/8"
C 1604	16" x 4"
C 164	16" x 4-15/16"
C 166	16" x 6"
C 168	16" x 7-3/4"

Note 3: Cast aluminum vents are standard in mill finish and do not contain mortar ribs.

FINISHES

204-R1 clear anodized finish is standard on all extruded aluminum vents. Mill finish, medium bronze anodized, dark bronze anodized are also available and are in stock for extruded aluminum vents.

Mill finish is standard on all cast aluminum vents. Cast aluminum vents can not be anodized. Baked enamel finishes in both standard and custom colors are also available on both extruded and cast aluminum vents.

Baked Enamel Standard colors include:

- **Bone White**
- **Brick Red**
- **Black**
- **Statuary Bronze**

Kynar finishes are also available on all vents.

Extruded Aluminum Vents

CUSTOM SIZES READILY AVAILABLE!



EX SERIES EXTRUDED ALUMINUM VENTS

Sunvent "EX"

Extruded Vents are the answer where a fine finish is a requisite, where a superior vent is required at a minimum cost. The vents are designed with a deep louvered overlapping blade, the blade itself has a storm stop at the rear, with a high waterstop at the rear of vent.

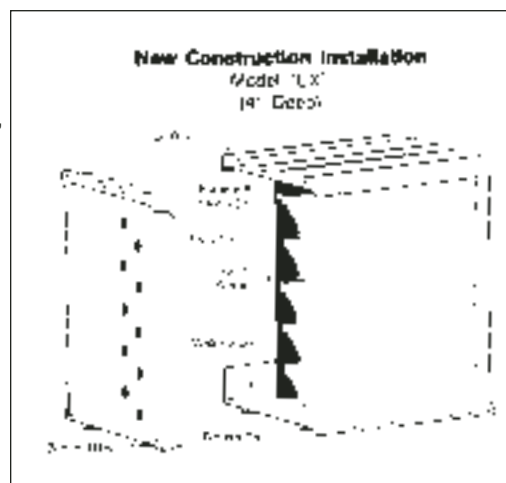

FL SERIES EXTRUDED ALUMINUM FLANGE VENTS

Sunvent Flange "FL"

Extruded Vents make possible simplified installation in existing walls. Chopped-out hole need not be "finished". An attractive appearance is assured by flange.

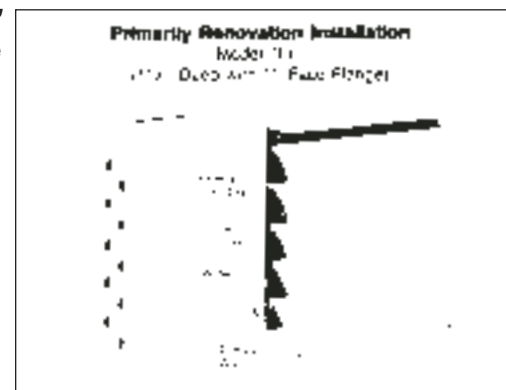

EXCLUSIVE FEATURES

- Available in any special size to suit any job design
- All extruded sections
- Minimum .125" thickness
- 1" Deep Overlapping Blades
- 204-R1 Clear Anodized finish standard
- Made in any length up to 8 ft. without front mullions—continuous blade effect
- Continuous weepage on bottom
- Overlapping blades
- All blades at 45 degrees

EXTRUDED ALUMINUM STOCK VENT SIZES

		Order Sizes (See notes 1 and 2) W x H
4"Deep	1 1/2"Deep w/1"Flange	
EX 825	FL 825	8-1/8" x 2-3/8"
EX 847	FL 847	8-1/8" x 4-3/4"
EX 808	FL 808	8-1/8" x 7-3/4"
EX 125	FL 125	12" x 4-3/4"
EX 128	FL 128	12" x 7-3/4"
EX 1212	FL 1212	12" x 11-3/4"
EX 157	FL 157	15-5/8" x 7-3/4"
EX 1516	FL 1516	15-5/8" x 15-3/4"
EX 162	FL 162	16-1/2" x 2-3/8"
EX 164	FL 164	16-1/2" x 4-3/4"
EX 168	FL 168	16-1/2" x 7-3/4"
EX 1616	FL 1616	16-1/2" x 15-3/4"
EX 244	FL 244	24" x 4-3/4"
EX 248	FL 248	24" x 7-3/4"
EX 3208	FL 3208	32" x 7-3/4"
EX 4808	FL 4808	48" x 7-3/4"

Note 1: EX vents add 1/4" to order height for ribs.

Note 2: FL vents add 1" face flange on 4 sides to order size.

Add 1/4" to order width for mechanical fastener heads.

"EX" and "FL" Extruded Vents can be readily made to any specified height or width without exposed mullions.

BRICK VENT ACCESSORIES

SUGGESTED SPECIFICATION:

See our full 3 part specification on the Sweets CD and at www.sweets.com. Find us in section 10235.

EXTRUDED ALUMINUM:

Furnish and install where indicated on drawings Sylro/Sunvent brick vents. Model "EX" or "FL"(choose one), choose model number or size of vent, as manufactured by Sylro/Sunvent Industries, Pelham, NH, 1-800-325-4115. Brick vents to be constructed of extruded aluminum sections, minimum thickness is .125", 6063-T5 alloy. Vents are supplied with 18x14 aluminum mesh insect screen and 204-R1 clear anodized finish. (Medium bronze anodized, Dark bronze anodized, mill finish, baked enamel or kynar finish also available-please specify). Specify if any dampers (manually operable from exterior or manually operable from interior of building) are required. Specify if any ductwork (.063" sheet metal) is required and specify the overall wall thickness if a duct extension is required. (See accessory items at right).

CAST ALUMINUM:

Furnish and install where indicated on drawings Sylro/Sunvent brick vents. Model "C", choose model number or size of vent, as manufactured by Sylro/Sunvent Industries, Pelham, NH, 1-800-325-4115. Brick vents to be constructed of cast aluminum, minimum thickness is .125", 319 alloy. Vents are supplied with 7x7 aluminum mesh insect screen and mill finish (baked enamel and kynar finish also available-please specify). Specify if any dampers (manually operable from exterior or manually operable from interior of building) are required. Specify if any ductwork (24 gauge galvanized) is required and specify the overall wall thickness if a duct extension is required. (See accessory items at right).

CUSTOM FABRICATION:

Extruded aluminum brick vents (models "EX" or "FL") can be readily manufactured in any special size to suit your job design up to 96"W x 96"H. Cast aluminum brick vents are manufactured from specific mold sizes and are available in only the sizes shown on the cast aluminum stock vent size chart.

ORDERING/SHIPPING:

Contact us at our toll-free telephone number or e-mail your request to us for pricing, as well as for any assistance or guidance in sizing your venting needs.

Sunvent Industries extruded aluminum brick vents typically ship in 1-2 days in an in-stock finish (mill, 204-R1 clear anodized, medium bronze anodized, dark bronze anodized). Custom sized extruded vents ship within 2-4 days. Baked enamel standard colored vents ship within 2 weeks; custom colors within 3 weeks; kynar finished vents ship within 3-4 weeks.

Sunvent Industries cast aluminum brick vents typically ship within 1-5 days in mill finish. Baked enamel standard colored vents ship within 2 weeks; custom colors within 3 weeks; kynar finished vents ship within 3-4 weeks.

SCREENS:

18x14 aluminum mesh insect screen is standard on all extruded aluminum vents. 7x7 aluminum mesh insect screen is standard on all cast aluminum vents.

Aluminum Vent with Opposed Blade Damper

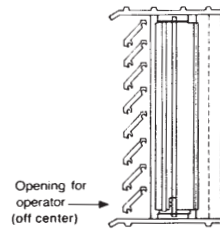

Aluminum Vent with Opposed Blade Damper operable from exterior with screwdriver. (Available in Model "EX" only)

Aluminum Vent with Exterior Operated Damper

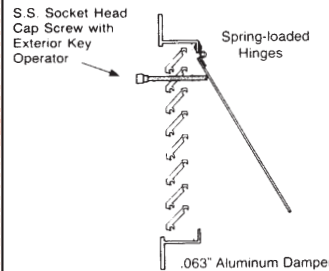

Aluminum Vent with Damper and Exterior Key Operator. (Available in Models "FL" or "C")

Aluminum Vent with Straight Duct

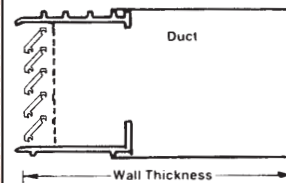

Straight Ducts, made of .063" aluminum for models "EX" or "FL"; or made of 24 gauge galvanized for model "C", securely fastened to vent. Specify vent type and wall thickness.

Aluminum Vent with Duct and Inside Register

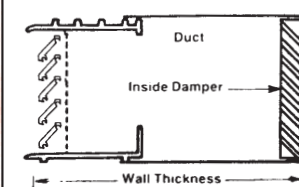

Duct to be .063" aluminum for models "EX" or "FL"; or made of 24 gauge galvanized for model "C". Aluminum register with individual vanes and aluminum multiblade damper. Register cannot be attached directly to vent or duct sleeve but can be shipped loose. Duct may not be necessary for your application.



Sunvent Industries

a division of Sylro Sales Corporation

One Industrial Drive, #26, Pelham, NH 03076

TOLL FREE: 1.800.325.4115 IN NH: 603.595.4556

FAX: 603.595.4778

E-mail: info@sunventindustries.com

www.sunventindustries.com